

IIT-JAM Physics Paper - 2009

Instructions:

- Attempt all the 25 questions.
- Questions 1-15 (Objective questions) carry six marks each and each questions 16-25 (Subjective questions) carry twenty one marks each.

1. Isothermal compressibility κ_T of a substance is defined as $\kappa_T = -\frac{1}{V} \left(\frac{\partial V}{\partial P} \right)_T$. Its value for n mole of an ideal gas will be

- (a) $\frac{1}{P}$ (b) $\frac{n}{P}$ (c) $-\frac{1}{P}$ (d) $-\frac{n}{P}$

2. A space crew has a life support system that can last only for 1000 hours. What minimum speed would be required for safe travel of the crew between two space stations separated by a fixed distance of 1.08×10^{12} km?

- (a) $\frac{c}{\sqrt{3}}$ (b) $\frac{c}{\sqrt{2}}$ (c) $\frac{c}{2}$ (d) $\frac{c}{\sqrt{5}}$

3. An oscillating voltage $V(t) = V_0 \cos \omega t$ is applied across a parallel plate capacitor having a plate separation d. The displacement current density through the capacitor is:

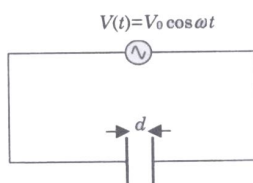

- (a) $\frac{\epsilon_0 \omega V_0 \cos \omega t}{d}$ (b) $\frac{\epsilon_0 \mu_0 \omega V_0 \cos \omega t}{d}$ (c) $-\frac{\epsilon_0 \mu_0 \omega V_0 \sin \omega t}{d}$ (d) $-\frac{\epsilon_0 \omega V_0 \sin \omega t}{d}$

4. Two spherical nuclei have mass numbers 216 and 64 with their radii R_1 and R_2 respectively. The ratio $\frac{R_1}{R_2}$ is:

- (a) 1.0 (b) 1.5 (c) 2.0 (d) 2.5

5. In the Fourier series of the periodic function (shown in the figure)

$$f(x) = |\sin x|$$

$$= \sum_{n=0}^{\infty} [\alpha_n \cos nx + \beta_n \sin nx]$$

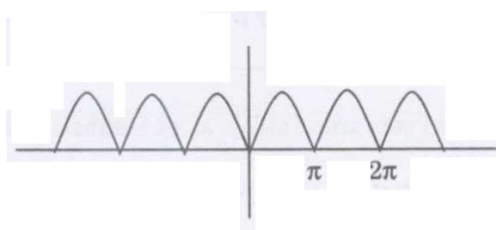

Which of the following coefficients are nonzero?

- (a) α_n for odd n (b) α_n for even n (c) β_n for odd n (d) β_n for even n

6. A particle is moving in space with O as the origin. Some possible expressions for its position, velocity and acceleration in cylindrical coordinates (ρ, φ, z) are given below. Which one of these is correct?

(a) Position vector $\vec{r} = \rho\hat{\rho} + \rho\varphi\hat{\phi} + z\hat{z}$ and velocity $\vec{v} = \frac{d\rho}{dt}\hat{\rho} + \rho\frac{d\varphi}{dt}\hat{\phi} + \frac{dz}{dt}\hat{z}$.

(b) velocity $v = \frac{d\rho}{dt}\hat{\rho} + \rho\frac{d\varphi}{dt} + \frac{dz}{dt}\hat{z}$ and acceleration $\vec{a} = \frac{d^2\rho}{dt^2}\hat{\rho} + \frac{d}{dt}\left(\rho\frac{d\varphi}{dt}\hat{\phi}\right) + \frac{d^2z}{dt^2}\hat{z}$

(c) Position vector $\vec{r} = \rho\hat{\rho} + z\hat{z}$ and velocity $\vec{v} = \frac{d\rho}{dt}\hat{\rho} + \rho\frac{d\varphi}{dt}\hat{\phi} + \frac{dz}{dt}\hat{z}$

(d) Position vector $\vec{r} = \rho\hat{\rho} + \rho\varphi\hat{\phi} + z\hat{z}$ and velocity $\vec{v} = \frac{d\rho}{dt}\hat{\rho} + \frac{d}{dt}(\rho\varphi\hat{\phi}) + \frac{dz}{dt}\hat{z}$

7. Which one of the following is an INCORRECT boolean expression?

(a) $\bar{P}Q + PQ = Q$

(b) $(P + \bar{Q})(P + Q) = P$

(c) $P(P + Q) = Q$

(d) $(\bar{P}\bar{Q}\bar{R} + \bar{P}\bar{Q}R + P\bar{Q}\bar{R} + P\bar{Q}R) = \bar{Q}$

8. Monochromatic X rays of wavelength 1\AA are incident on a simple cubic crystal. The first order Brag reflection from (311) plane occurs at an angle of 30° from the plane. The lattice parameter of the crystal in \AA is:

(a) 1 (b) $\sqrt{3}$ (c) $\sqrt{\frac{11}{2}}$ (d) $\sqrt{11}$

9. An electron field $\vec{E}(\vec{r}) = \frac{1}{r}(a\hat{r} + \beta \sin \theta \cos \phi\hat{\phi})$ exists in space. What will be the total charge enclosed in a sphere of unit radius centered at the origin?

(a) $4\pi\epsilon_0 a$ (b) $4\pi\epsilon_0 (\alpha + \beta)$ (c) $4\pi\epsilon_0 (\alpha - \beta)$ (d) $4\pi\epsilon_0 \beta$

10. A thin massless rod of length $2L$ has equal point masses ‘m’ attached at its ends (see figure). The rod is rotating about an axis passing through its centre and making angle θ with it. the magnitude of the rate of change of its

angular momentum $\left|\frac{d\vec{L}}{dt}\right|$ is:

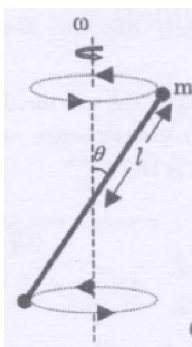

(a) $2m\ell^2\omega^2 \sin \theta \cos \theta$ (b) $2m\ell^2\omega^2 \sin \theta$
 (c) $2m\ell^2\omega^2 \sin^2 \theta$ (d) $2m\ell^2\omega^2 \cos^2 \theta$

11. A battery with a constant emf ε and internal resistance r_i provides power to an external circuit with a load resistance made up by combining resistance R_L and $2R_L$ in parallel. For what value of R_L will the power delivered to the load be maximum?

- (a) $R_L = \frac{r_i}{4}$ (b) $R_L = \frac{r_i}{2}$
 (c) $R_L = \frac{2}{3}r_i$ (d) $R_L = \frac{3}{2}r_i$

12. Among the following displacement versus time plots, which ones may represent an overdamped oscillator?

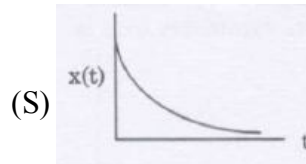
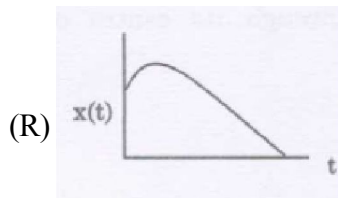
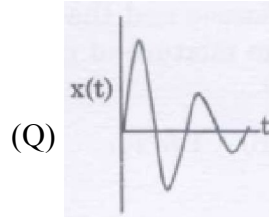
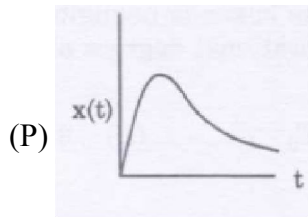

- (a) Only (P) and (Q) (b) Only (P) and (R)
 (c) Only (P) and (S) (d) Only (P), (R), (S)

13. A wav packet in a certain medium is constructed by superposing waves of frequency ω around $\omega_0 = 100$ and the corresponding wave-number k with $k_0 = 10$ as given in the table below

ω	k
81.00	9.0
90.25	9.5
100.00	10.0
110.25	10.5
121.00	11.0

Find the ratio v_g / v_p of the group velocity v_g and the phase velocity v_p .

- (a) $\frac{1}{2}$ (b) 1 (c) $\frac{3}{2}$ (d) 2

14. A box containing 2 moles of diatomic ideal gas at temperature T_0 is connected to another identical box containing 2 moles of a monoatomic ideal gas at temperature $5T_0$. There are no thermal losses and the heat capacity of the box is negligible. Find the final temperature of the mixture of the gases (ignore the vibrational degrees of freedom for the diatomic molecules)

- (a) T_0 (b) $1.5 T_0$ (c) $2.5 T_0$ (d) $3 T_0$

15. Moment of inertia of a solid cylinder of mass m , height ' h ' and radius ' r ' about an axis (shown in the figure by dashed line) passing through its centre of mass and perpendicular to its symmetry axis is:

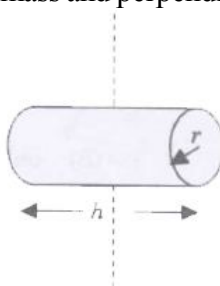

- (a) $\frac{1}{4}mr^2 + \frac{1}{12}mh^2$ (b) $\frac{1}{2}mr^2 + \frac{1}{8}mh^2$ (c) $\frac{1}{2}mr^2 + \frac{1}{12}mh^2$ (d) $\frac{1}{2}mr^2 + \frac{1}{4}mh^2$
16. A parallel beam of light of diameter 1.8 cm contains two wavelengths 4999.75\AA and 5000.25\AA . The light is incident perpendicular on a large diffraction grating with 5000 lines per centimeter.
- (a) Using Rayleigh criterion, find the least order at which the two wavelengths are resolved.
- (b) What will be the angular separation (in radians) of the two wavelengths at order $n = 2$?
17. A block of mass ' M ' is free to slide on a frictionless horizontal floor. The block has a cylindrical cavity of radius R in the middle of it. The centre of mass (CM) of the block lies on the dashed line passing through the centre of the cavity (see figure). Initially the CM of the block is at a horizontal distance X_1 from the origin. Now a point particle of mass ' m ' is released from A into the cavity. There is negligible friction between the particle and the cavity surface. When the particle reaches point B, the CM of the block is at a distance X_2 from the origin. Find $(X_2 - X_1)$.

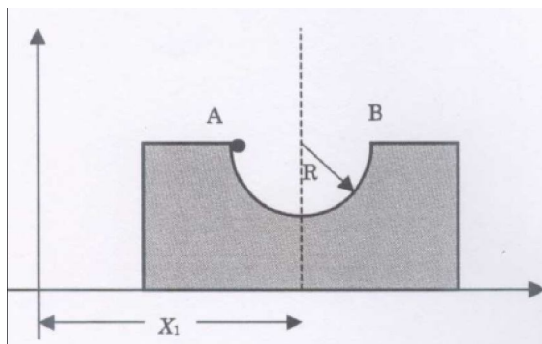

18. The electric field of an electromagnetic wave propagating through vacuum is given by
- $$\vec{E}(\vec{r}, t) = E_0 \hat{z} \cos(100\sqrt{3}\pi x - 100\pi y - \omega t)$$
- (a) What is the wave vector \hat{k} ? Hence, find the value of ω .
- (b) At the time $t = 0$ there is a point charge ' q ' with velocity $\vec{v} = v_0 \hat{x}$ at the origin. What is the instantaneous Lorentz force acting on the particle?

19. Consider two infinitely long wires parallel to the z-axis carrying the same current I. One wire passes through the point L with coordinates (-1, 1) and the other through M with coordinates (-1, -1) in the XY plane as shown in the figure. The direction of the current in both the wires is in the positive z-direction.

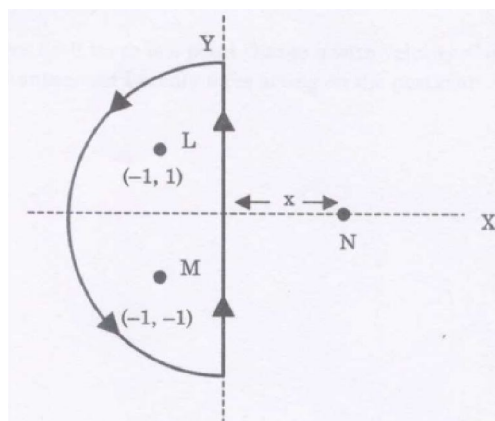

- (a) Find the value of $\oint \vec{B} \cdot d\vec{l}$ along the semicircular closed path of the radius 2 units shown in the figure.
- (b) Third long wire carrying current I and also perpendicular to the XY plane is placed at a point N with coordinates (x, 0) so that the magnetic field at the origin is doubled. Find x and the direction of the current in the third wire.
20. A particle of mass 'm' is confined in a one dimensional box of unit length. At time $t = 0$ the wavefunction of the particle is $\psi(x, 0) = A \sin 2\pi x \cos \pi x$ where A is the normalization constant.
- (a) Write the wavefunction $\psi(x, t)$ at a later time t.
- (b) Find the expectation values of momentum and energy at $t = 0$.
21. For the transistor circuit shown in the figure $\beta_{dc} = 100$ and $V_{BE} = 0.7 V$. Determine the base current I_B , the collector-emitter voltage V_{CE} , the emitter voltage V_E , the emitter voltage V_E , the base voltage V_B and the saturation current I_{Csat} .

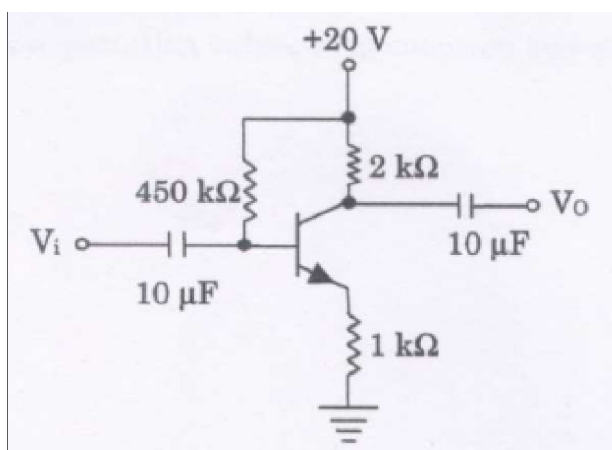

22. The equation of state of one mole of a van der Waals gas is $\left(p + \frac{a}{V^2}\right)(V - b) = RT$ and its internal energy

$U(T, V)$ is given by $U(T, V) = U_0 + C_V T - \frac{a}{V}$, where U_0 and C_V can be taken as constants.

(a) Prove that in a reversible adiabatic process the temperature and volume satisfy the equation $T(V - b)^{R/C_V} = \text{constant}$.

(b) Calculate the change in entropy of the gas when it undergoes a reversible isothermal expansion from volume V_0 to $2V_0$.

23. (a) Find the normalized eigenvector α of the matrix $M = \begin{bmatrix} 0 & 1 \\ 1 & 0 \end{bmatrix}$, corresponding to its positive eigenvalue.

(b) The normalized eigenvectors of the matrix $N = \begin{bmatrix} 0 & -i \\ i & 0 \end{bmatrix}$ are β_1 and β_2 with the eigenvalues λ_1 and λ_2

respectively and $\lambda_1 > \lambda_2$. If the eigenvector α obtained in part (a) is expressed as $\alpha = P\beta_1 + Q\beta_2$. Find the constants P and Q.

24. A particle of mass 'm' is shown is thrown vertically up from the ground with initial speed V_0 . As it moves it experiences a drag force $|F_{drag}| = kv^2$, where v is the speed of the particle and k is a constant UP to what height does the particle go and what its speed when it reaches the ground again?

25. Consider the radioactive transformation $A \rightarrow B \rightarrow C$ with decay constants, λ_A and λ_B for elements A and B; C is a stable element. Assume that at $t = 0$, $N_A = N_0$, $N_B = 0$ and $N_C = 0$, where N_A , N_B and N_C are the number of atoms of A, B and C, respectively.

(a) Show that at any later time t the number of atoms N_A of element B will be

$$N_B(t) = \frac{N_0 \lambda_A}{\lambda_B - \lambda_A} \left[e^{-\lambda_A t} - e^{-\lambda_B t} \right]$$

(b) Sketch the qualitatively the variation of N_A , N_B and N_C with time on three separate plots.